



GENERAL TRADING & CONTRACTING Co.
شركة وسم للتجارة العامة والمقاولات

OFFICE POWER DATA SOLUTIONS

Product Catalog



WASEM GENERAL TRADING & CONTRACTING COMPAN

Email: ahmad@wasem-kw.com

www.wasem-kw.com



OFFICE POWER & DATA SOLUTIONS

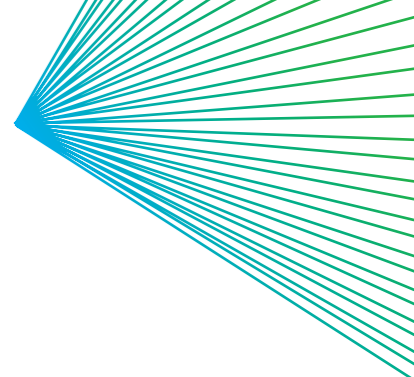

ABOUT US

Our Electrical Manufacturing facility is at Leliu town in Foshan, China. This industrial town famous for manufacturing hardware. We specializes in developing and manufacturing office hardware and cable management products. We operate it's business on a policy of " Service - Quality - Safety". This enables the company to achieve highly respected reputation in the commercial office accessories industry, providing cost effective and innovative 'Solutions by Design'.

We produce varieties series of tabletop power and data , Our intelligent hardware and electrics can now be found in workstations, meeting room, head table, podium, home office, call centers, bank, hotel, airport lounges, sports centers, shopping centers, service-counters, AV studios and many more - all over the world.



Office power & data solutions

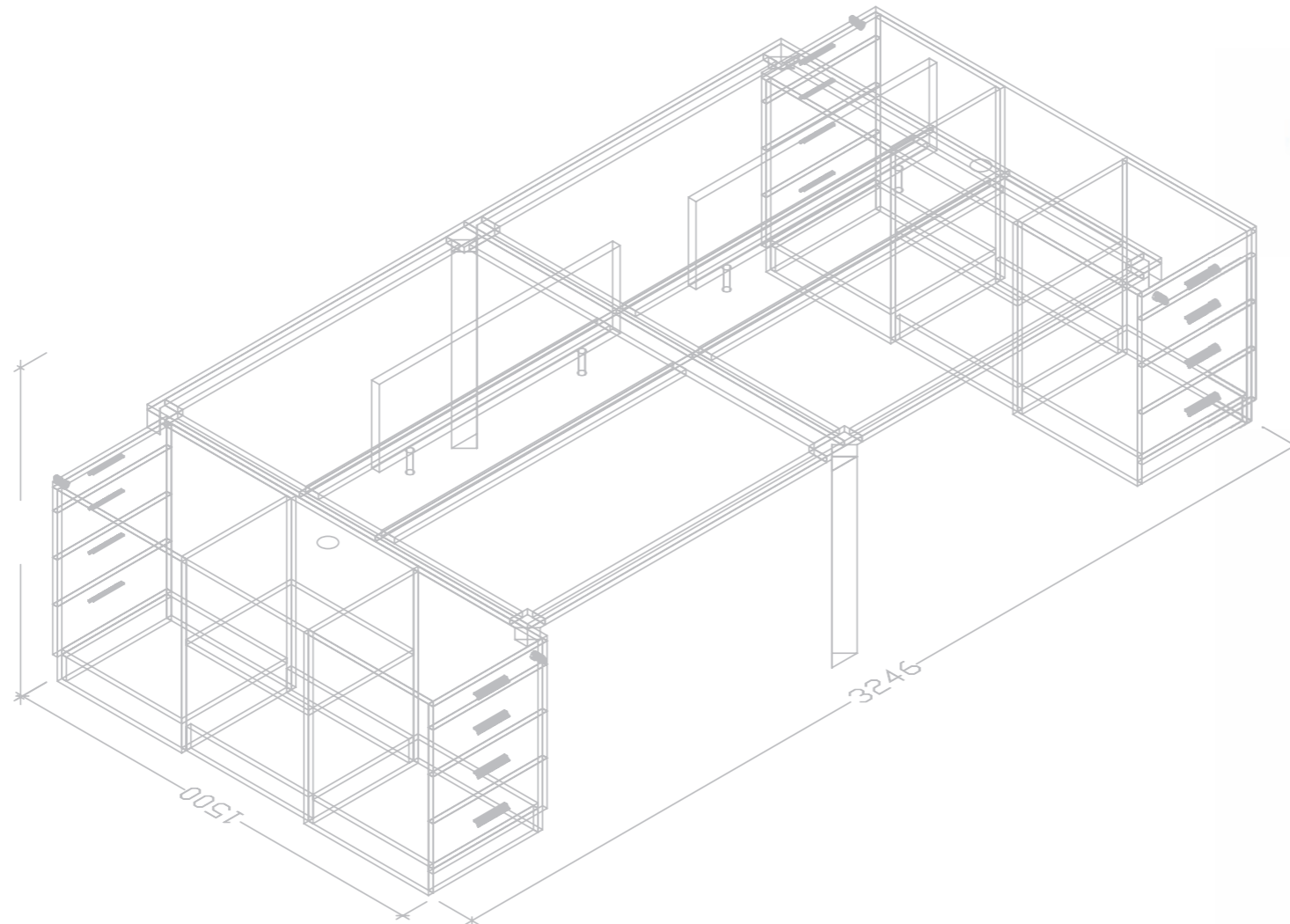



Production Line

Strength,
Quality assurance

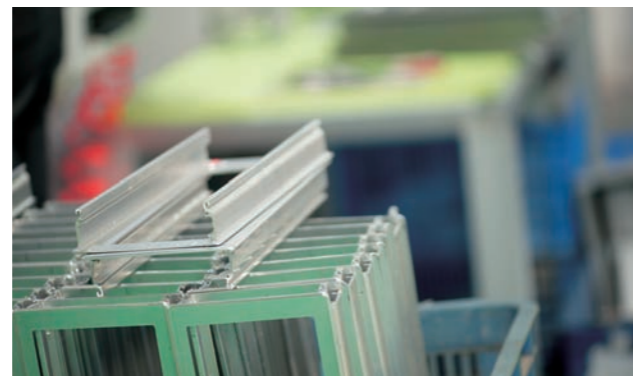

CONTENT

RM001、RM003、RM004L.....	02	RM502、RM503.....	32
RM004A、RM031、RM033.....	03	RM606、RM607、RM608.....	33
RM034、RM034K、RM034M.....	04	RM601.....	34
RM035、RM035X、RM035Y.....	05	RM602、RM603、RM604.....	35
RM035K、RM035M.....	06	RM605.....	36
RM007.....	07	DG01.....	37
RM008、RM021、RM022.....	08	DG02、DG03、DG04.....	38
RM005、RM005A.....	09	DG05、DG06.....	39
RM006、RM010、RM101B.....	10	ZD001、ZD002.....	40
RM009、RM041、RM042.....	11	ZD003、ZD004.....	41
SL001、SL004A、SL004B.....	12	YS01、MA001.....	42
SL002A、SL002B、SL003.....	13	PJ101、PJ102、PJ103.....	44
RM201、RM202.....	15	TJ001、TJ002.....	45
RM203.....	16	TJ003、TJ004.....	46
RM207、RM207B.....	17	TJ005、TJ007.....	47
RM208、RM208B.....	18	PX001、PX002.....	48
RM205、RM209.....	19	PX003、PX004.....	49
RM204、RM101A.....	20	TT01.....	50
RM210、RM211.....	21	TT02、TT03.....	51
LZ001、LZ002.....	23	RM701、RM702、RM703.....	53
LZ003、LZ003B.....	24	RM705、RM707、DM001、DM002、DM003、DM004.....	54
LZ201、LZ202.....	25	TQ001、TQ002、TQ003、TQ004、.....	55
LZ301.....	26	TQ005、JP001、JP002、JP003、JP004、JP005、YB01、YH01..	56
RM301、RM302.....	27	ZJ001、ZJ002、ZJ003、ZJ004.....	57
RM303.....	28	XG001、XG002、XG003、XG004.....	58
RM305、RM801.....	29	PF001、PF002、GC001、GL001.....	59
RM802.....	30	LG01、LG02、ZJ201、JK001.....	60
RM501.....	31		





ALUMINUM CABLE GROMMET DESKTOP HOLE COVER



RM001 Rectangular Cable Grommet

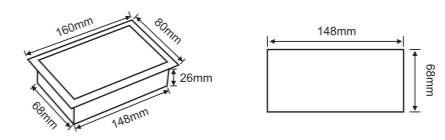

80x80	68x68
80x160	68x148
80x280	68x268
80x300	68x288
100x300	88x288
100x400	88x388
120x300	108x288
120x400	108x388

Material	Aluminum
Finishes	Anodized silver, Anodized black (Customizable)
Size	160*80*28mm(Customizable)
Open hole size	148*68*26mm



RM003 Cable Grommet with Hydraulic Pole

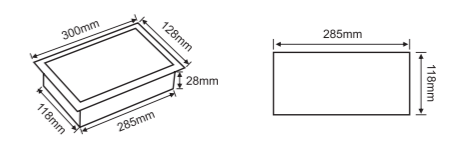

Material	Aluminum+ABS
Finishes	Powder coated white, Painting silver (Customizable)
Size	300*128*30mm (Length customizable)
Open hole size	285*118*28mm



RM004L Soft-closing Cable Grommet

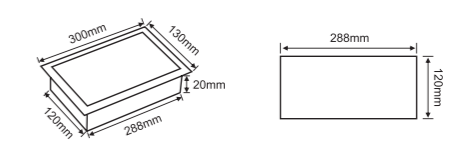

300*130	288*120
400*130	388*120

Material	Aluminum+ABS end cap
Finishes	Powder coated white, Painting silver (Customizable)
Size	300*130*23mm(Length customizable)
Open hole size	288*120*20mm



RM004A Soft-closing Cable Grommet

Material	Aluminum+Aluminum end cap
Finishes	Powder coated white, Painting silver (Customizable)
Size	300*127*28mm(Length customizable)
Open hole size	291*110*26mm

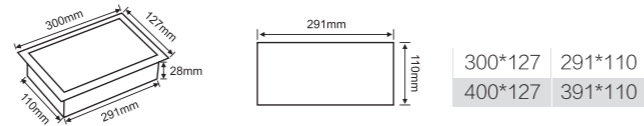

RM031 Soft-closing Cable Grommet All-in-one

Material	Aluminum
Finishes	Brushed silver,Brushed black(Customizable)
Size	300*120*33mm(Length customizable)
Open hole size	290*102*31mm

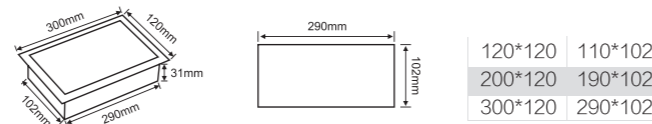

RM033 Soft-closing Cable Grommet All-in-one

Material	Aluminum
Finishes	Brushed silver,Brushed black(Customizable)
Size	300*91*26mm(Length customizable)
Open hole size	288*78*24mm

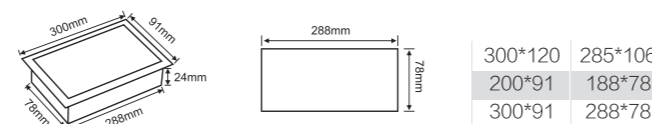

RM034 Soft-closing Cable Grommet All-in-one

Material	Aluminum
Finishes	White, Silver, Brushed silver/black (Customizable)
Size	300*92*33mm(Length customizable)
Open hole size	290*82*31mm

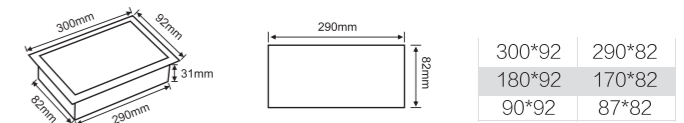

RM034K Desktop Recessed Power & Data Box

Material	Aluminum
Finishes	White, Silver,Brushed silver/Black(Color customizable)
Size	300*92*97mm
Open hole size	294*82*95mm

Configuration (Customizable)

[A] 2*Power 1*USB charger 1*Tel 1*RJ45 Data 1* HDMI

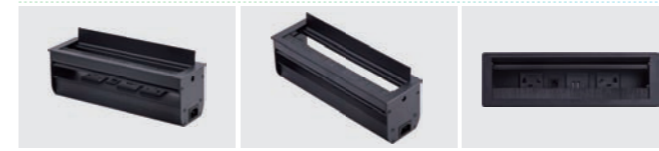

RM034M Modules Modular Recessed Power & Data Box

Material	Aluminum
Finishes	White, Silver,Brushed silver/Black(Color customizable)
Size	300*92*97mm
Open hole size	294*82*95mm

Configuration (Customizable)

[A] 2*Power 1*USB charger 1*Tel 1*RJ45 Data 1* HDMI



One hole size, three solutions

RM035



RM035X



RM035Y



RM035

Soft-closing Cable Grommet All-in-one



Material	Aluminum
Color	White, Silver, Brushed silver/black (Customizable)
Size	300*120*33mm (Length customizable)
Open hole size	290*110*31mm

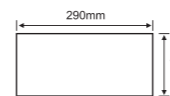
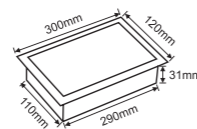

300*120	290*110
400*120	390*110

Product features

- Feature **aluminum seamless frame** and **Lid soft closing flat**.
- **All-in-one construction** more stable make for a beautiful cable management solution for any workstation or conference table.
- **Available in any length** to fit the needs of your particular application.
- **While brushed luxury finish.** Available in various sleek color finishes to match or compliment your desk or décor. Powder coating and painting finish suit modern desktop.
- Similar to RM034, but bigger breadth.

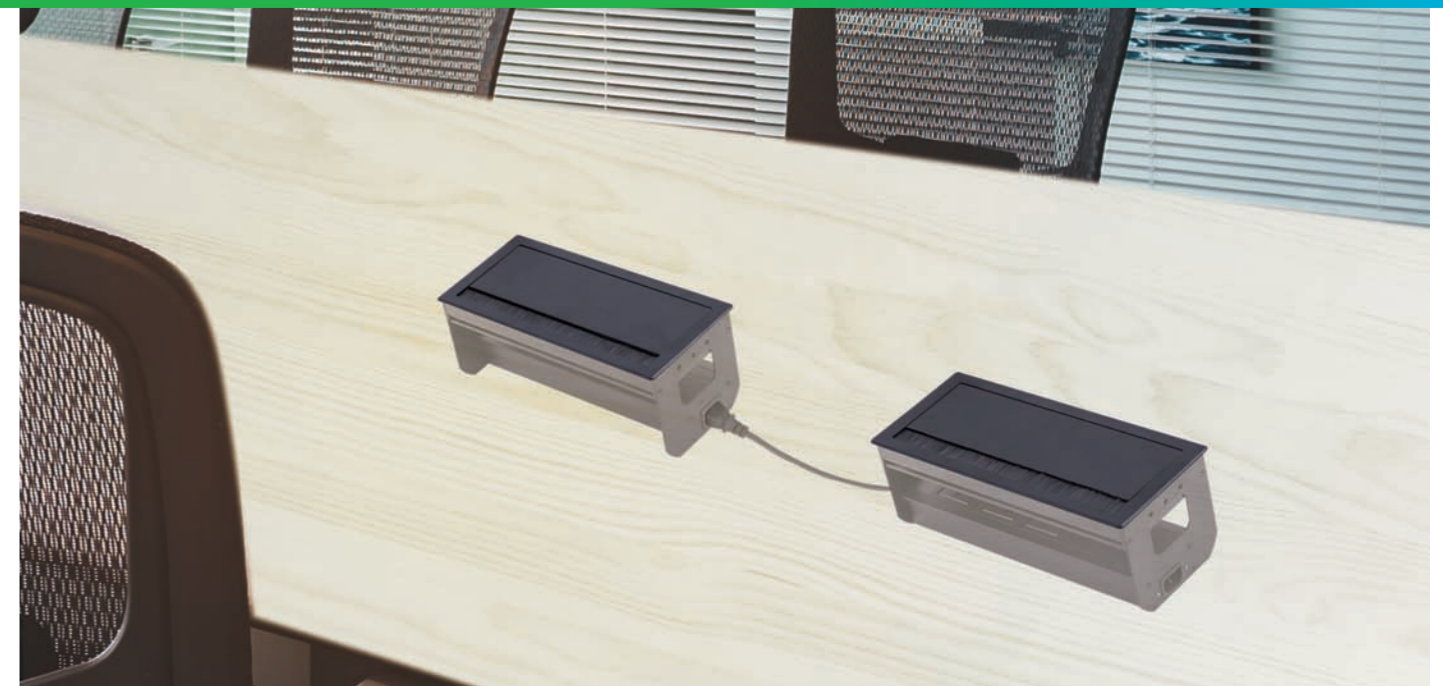

RM035K

Desktop Recessed Power & Data Box



Material	Aluminum
Finishes	White, Silver, Brushed silver/Black (Color customizable)
Size	300*120*112mm
Open hole size	294*110*110mm

Configuration (Customizable)

【 A 】 2*Power 1*USB charger 1*Tel 1*RJ45 Data 1*HDMI



RM035M

Modules Modular Recessed Power & Data Box



Material	Aluminum
Finishes	White, Silver, Brushed silver/Black (Color customizable)
Size	300*120*112mm
Open hole size	294*110*110mm

Configuration (Customizable)

【 A 】 2*Power 1*USB charger 1*Tel 1*RJ45 Data 1*HDMI





RM007 Double-sided Cable Grommet Soft-closing

Material	Aluminum
Finishes	Anodized silver
Size	600*148*44mm (Length customizable)
Open hole size	590*140*42mm

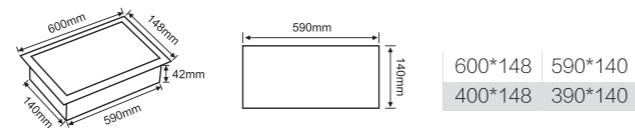

Product features

- Flexible cable management includes brush liners on either side for cable pass-through.
- Gear buffering, silent opening and closing.
- **Double-sided open design more flexible**, access to cable from both side, suitable for boardrooms and conference rooms.
- **Aluminium cover** with high-quality feel.



RM008 Double-open Partition Trunking

Material	Aluminum
Finishes	Anodized silver
Size	1200*240*25mm (Length customizable)

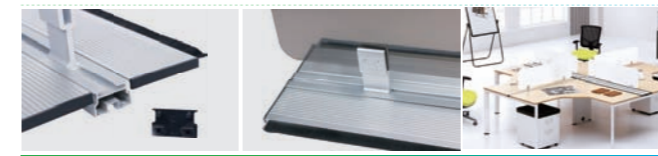
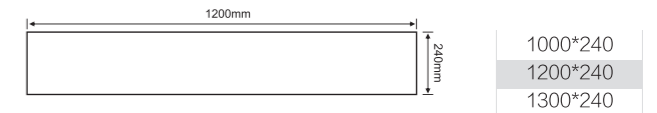

RM021 Double-sided Cable Grommet

Material	Aluminum
Finishes	Anodized silver
Size	300*145*28mm (Length customizable)
Open hole size	288*133*26mm

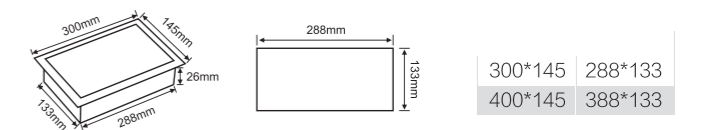

RM022 Double-sided Cable Grommet Soft-closing

Material	Aluminum
Finishes	Powder coated white, Painting silver
Size	400*214*27mm (Length customizable)
Open hole size	392*198*25mm

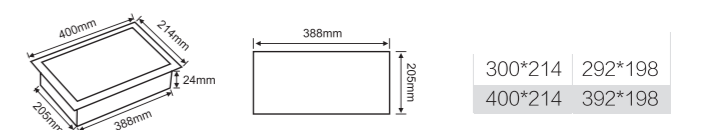

RM005 Desktop Outlet Box

Material	Aluminum
Finishes	Anodized silver (Color customizable)
Size	300*145*102mm (Length customizable)
Open hole size	284*118*100mm

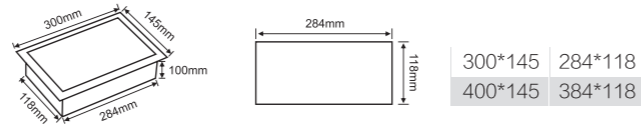
RM005A Desktop Outlet Box with Soft-closing

Material	Aluminum
Finishes	Painting silver (Color customizable)
Size	300*135*102mm(Length customizable)
Open hole size	290*120*100mm

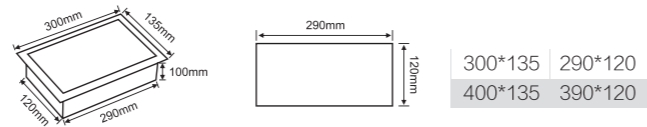
Product features

- Desk power management solution with internal wall outlet. Keep desktop tidy and power accessible at the surface level.
- Feature a **hydraulic soft-closing lid**.
- Applicable **wall outlet** type: **120*120mm, 86*86mm**.
- **Available in any length** to fit the needs of your particular application.
- Side hole allow cabling and running wires up from underneath the desktop.
- Bottom hole designed to wiring socket cable.
- With **soft brush assembled in box frame**, preventing dust and allowing wires and cable to pass through safely and neatly.
- Similar to RM005, but with **hydraulic buffer damper** to flip up and soft closing, hot painting color is steady, protect lid from scratching.

RM006 Desktop Outlet Box All-in-one

Material	Aluminum
Finishes	Brushed silver; Brushed black (Color Customizable)
Size	300*120*112mm(Length customizable)
Open hole size	288*110*110mm

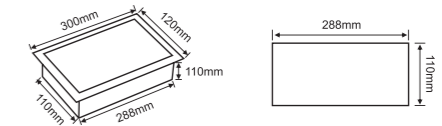
RM010 Double-sized Socket Box with Soft-closing

Material	Aluminum
Finishes	Painting silver
Size	300*145*140mm (Length customizable)
Open hole size	288*135*137mm

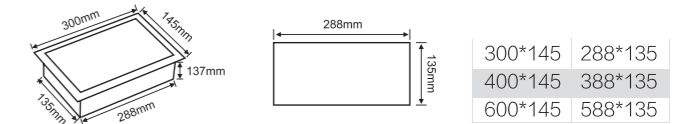
RM010B Double-sized Desktop Socket Box

Material	Aluminum+zinc alloy
Finishes	Painting silver
Size	300*148*128mm(Length customizable)
Open hole size	285*140*124mm

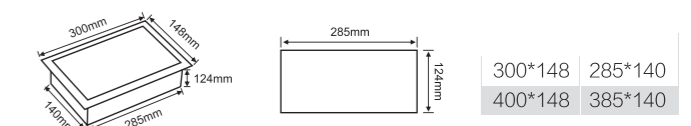



RM009 Wall Socket Box Underneath Desktop

Material	Aluminum
Finishes	Anodized silver
Size	330*107*110mm (Length customizable)

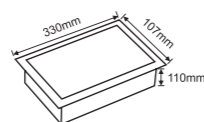

300*107
400*107



SL001 Square Plastic Cable Grommet

Material	ABS
Finishes	Silver,Black,White
Size	260*115*27mm
Open hole size	250*105*25mm

RM041 Wall Socket Outlet Trunking

Material	Aluminum+ABS
Finishes	White
Size	145*125*82*388mm

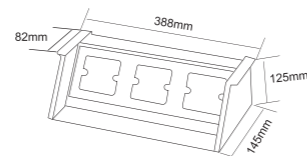

SL004A Square Plastic Cable Grommet

Material	ABS
Finishes	Silver, Black,White
Size	220*115*26mm
Open hole size	213*102*24mm

RM042 Wall Socket Outlet Trunking

Material	Aluminum+ABS
Finishes	White
Conventional color	White
Size	258*125*68*374mm

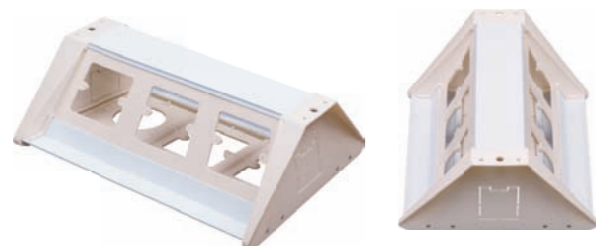
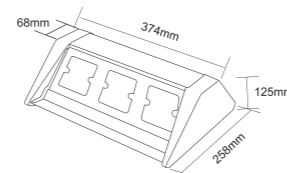

SL004B Square Plastic Cable Grommet

Material	ABS
Finishes	Silver, Black,White
Size	265*115*26mm
Open hole size	258*107*24mm



Style: A(left and right hole)

SL002A Square Plastic Cable Grommet

Material	ABS+Acrylic
color	Silver,Black,White,Yellow,Brown
Size	166*85*27mm
Open hole size	158*77*25mm



Style:B(up and down hole)

SL002B Square Plastic Cable Grommet

Material	ABS+Acrylic
color	Silver,Black,White,Yellow,Brown
Size	166*85*27mm
Open hole size	158*77*25mm



SL003 Square Plastic Cable Grommet

Material	ABS+Acrylic
Finishes	Silver, Black, White, Yellow, Brown
Size	250*107*28mm
Open hole size	244*98*26mm

FLIP-UP COVER POWER & DATA OUTLET BOX





RM201 Desktop Recessed Power & Data Box

Material	Aluminum
Finishes	Brushed silver, Brushed black (Color customizable)
Size	145*130*112mm
Open hole size	135*115*110mm

Configuration (Customizable)

1*USB	
1 Power	
1 RJ45 Data	
1 USB.	

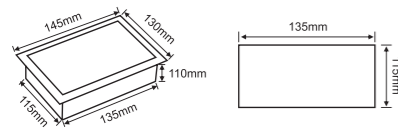

RM202 Double-open Desktop Power & Data Box

Material	Aluminum
Finishes	Brushed silver, Brushed black (Color customizable)
Size	266*130*112mm
Open hole size	255*115*110mm

Configuration (Customizable)

2 Powers	
2 RJ45 Data	
2 RJ11	
2 VGA	
2 USB	

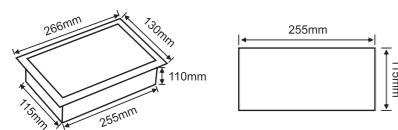

RM203 Desktop Recessed Power & Data Box

Material	Aluminum
Finishes	Brushed silver, Brushed black (Color customizable)
Size	266*130*112mm
Open hole size	255*115*110mm

Product features

- Provides USB & AC Power, data, and A/V connections to desktop.
 - **Concealable outlets** with a lid opening let you close the lid while devices are connected to **minimize workspace obstruction**.
 - Feature aluminum seamless frame and Lid soft closing flat.
 - **Brushed finish** with **textured face** presents a classy aesthetic that fits into any environment.
- Ideal for the conference room, classroom, courtroom, laboratory and more.
- Similar to RM205, RM207, RM208, RM209, but in different size.

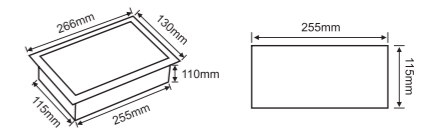

Configuration (Customizable)

2 Powers	
1 RJ45 Data	
1 RJ11	
1 3.5 Dual Audio	
1 VGA.	

RM207 Desktop Recessed Power & Data Box

Material	Aluminum
Finishes	Brushed silver, Brushed black (Customizable)
Size	160*100*62mm
Open hole size	146*87*61 mm

Configuration (Customizable)

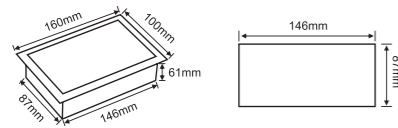

1 Power
1 RJ45 Data
1* RJ11

RM208 Desktop Recessed Power & Data Box

Material	Aluminum
Finishes	Brushed silver, Brushed black (Customizable)
Size	185*95*83mm
Open hole size	177*87*81 mm

Configuration (Customizable)

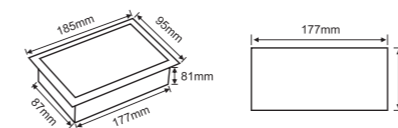

2 Powers
2 RJ45 Data
2 RJ11
2 VGA
1 Dual 3.5mm audio

RM207B 5 Modules Modular Power & Data Box

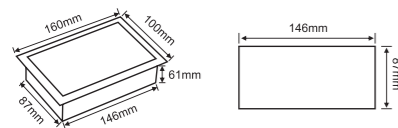

Material	Aluminum
Finishes	Brushed silver, Brushed black (Color customizable)
Size	160*100*62mm
Open hole size	146*87*61 mm

Configuration (Customizable see page P49)

RM208B 6 Modules Modular Power & Data Box

Material	Aluminum
Finishes	Brushed silver, Brushed black (Customizable)
Size	185*95*83mm
Open hole size	177*87*81 mm

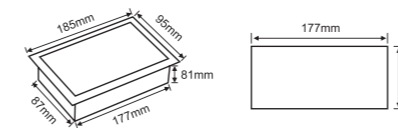
Configuration (Customizable see page P49)

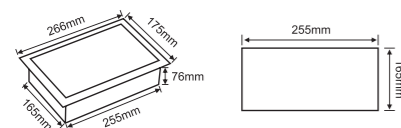

RM205
Double-sided Desktop Power & Data Box

Material	Aluminum
Finishes	Brushed silver, Brushed black (Customizable)
Size	265*175*78mm
Open hole size	255*165*76mm

Configuration (Customizable)

4 Powers, 2 RJ45 Data, 2 RJ11, 2 VGA, 2 Dual 3.5mm audio

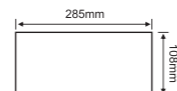
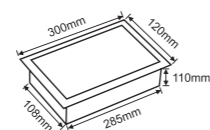

RM209
Desktop Recessed Power & Data Box

Material	Aluminum
Finishes	Brushed silver, Brushed black (Customizable)
Size	300*120*112mm
Open hole size	285*108*110 mm

Product features

- Provides USB & AC Power, data, and A/V connections to desktop
 - **Concealable outlets** with a lid opening let you close the lid while devices are connected to minimize workspace **obstruction**
 - Feature **aluminum seamless frame** and **soft closing** flip lid
 - **Brushed finish** with **textured face** presents a classy aesthetic that fits into any environment
- Ideal for the conference room, courtroom, workstation, laboratory and more
- Similar to RM203, RM205, RM207, RM208, but in different size.

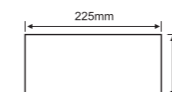
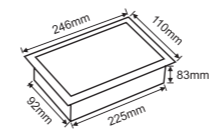
Configuration (Customizable)

RM204
Desktop Recessed Modular Power & Data Box

Material	Aluminum
Finishes	Anodized Silver (Color customizable)
Size	246*110*85 mm (Length customizable)
Open hole size	225*92*83 mm

Configuration (Customizable see page P49)

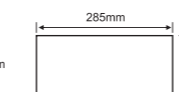
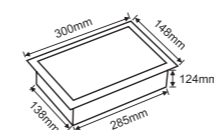
RM101A
Double-sided Power & Data Box

Material	Aluminum
Finishes	Painting silver (Customizable)
Size	300*148*128mm (Length customizable)
Open hole size	285*138*124mm

Configuration (Customizable see page P49)





RM210

Power & Data Box
With Wireless Charging

Material	Aluminum
Finishes	Brushed silver, Brushed black (Color customizable)
Size	400*120*112mm
Open hole size	385*110*110mm

Configuration (Customizable)

1 Wireless Charger, 3 Powers, 1 RJ45 Data, 1 RJ11, 1 VGA, 1 Dual 3.5mm audio

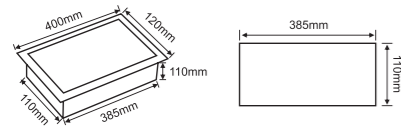

RM211

Power & Data Box
With Wireless Charging

Material	Aluminum
Finishes	Brushed silver, Brushed black (Color customizable)
Size	353*131*112mm
Open hole size	255*115*95mm

Product features

- Feature a Wireless Charging Station, provides USB & AC Power, data, and A/V connections to desktop
- Concealable outlets with a lid opening let you close the lid while devices are connected to minimize workspace obstruction
- Feature aluminum seamless frame and soft closing flip lid
- Brushed finish with textured face presents a classy aesthetic that fits into any environment
- Simply place your Qi compatible device on the flat charging surface and the device will start charging automatically. Not Qi compatible device?
- Don't worry, we offer Qi adaptor with three charging plugs, suitable for Apple, android and Type C port. No wires. No mess. No forgetting to bring a USB cable or AC adapter
- Similar with RM203

2*Power 1*Tel 1*RJ45 Data 1*VGA 1*Dual 3.5mm Audio 1*wireless charger

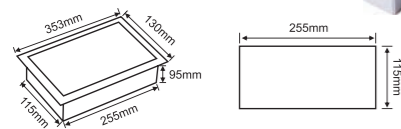

Configuration (Customizable)



BUILT-IN SOCKET OUTLET SURFACE MOUNT ELECTRICAL CONSOLE

LZ001 Built-in Socket Outlet



Material	Aluminum
Finishes	Brushed silver, Brushed black(Customizable)
Size	310*80*47 mm
Open hole size	270*65*42 mm

Product features



Configuration (Customizable)

- 2 Powers
- 1 Dual USB charger 2.1A
- 1 USB
- 1 HDMI
- 1 RJ45 Data
- 1 RJ11



LZ002 Built-in Socket Outlet



Material	Aluminum+ABS
Finish	Powder coated black
Size	360*94*36mm
Open hole size	330*65*32 mm

Configuration (Customizable)

- 1 Switch
- 2 Powers
- 2 RJ45 Data
- 1 RJ11
- 1 VGA



LZ003 Built-in Socket Outlet



Material	Aluminum
Conventional color	Brushed silver, Brushed black(Customizable)
Size	250*80*47 mm
Open hole size	210*65*42 mm

Product features



Configuration (Customizable)

【 A 】 3 Powers, 1 Dual USB charger 2.1A, 1 RJ45 Data, 1 RJ11



LZ003B Built-in Socket Outlet



Material	Aluminum
Conventional color	Brushed silver, Brushed black(Customizable)
Size	250*80*47mm
Open hole size	210*65*42 mm



Product features

Configuration (Customizable)

【 A 】 2*Power 1*USB charger 1*Tel, 1*RJ45 Data



- Flush Mount Multimedia Console
- All aluminum finished by CNC. **Brushed finish** with textured face, **smooth and delicate appearance** that fits into any environment.
- **Modules customizable** for request to fit different environment
- Widely use in the workstation of office, band and workspace, the tabletop of hotel and large meeting room
- Similar with LZ003

BUILT-IN SOCKET OUTLET SURFACE MOUNT ELECTRICAL CONSOLE



BUILT-IN SOCKET OUTLET



LZ201 Built-in Desk Modular Outlet

Material	Aluminum+
Finish	Anodized Silver, Anodized Black
Size	290*75*46mm
Open hole size	274*66*40mm



Configuration (Customizable)

【 A 】 3*Power 1*USB Charger

LZ202 Built-in Desk Outlet

Material	Aluminum
Finish	White,Black
Size	270*50*44mm
Open hole size	230*44*45mm



Configuration (Customizable)

【 A 】 3 Powers, 1 Dual USB charger 2.1A

【 B 】 3 Powers, 1 Dual USB charger 2.1A, 1 RJ45 Data, 1 RJ11

LZ301 Sliding Open Socket Outlet With Wireless Charger

Material	Aluminum
Finish	Silver,Sandblasted
Size	410*100*39mm(Length customizable)
Open hole size	380*72mm



Configuration (Customizable)

2*Power+1 Network + 1*Tel+1*dual USB Charger



LZ301-1



LZ301-3



LZ301-2



LZ301-4



LZ301-5



LZ301-6



LZ301-7

Product features

- Hide all connectors in flush surface when not in use.
- Space saving design that allow to be **slid open**.
- The **low mounting depth** allows it to be compactly integrated into worktops, or the wall, or installed above drawers.
- Modules customizable for request to fit different environment



RM301 Hydraulic Pop up Outlet Box

Material	Zinc alloy
Finishes	Painting silver, powder coated black
Size	138*135*67mm
Open hole size	130*120*65mm

Configuration (Customizable)



- 1 Power
- 1 VGA
- RJ45 Data

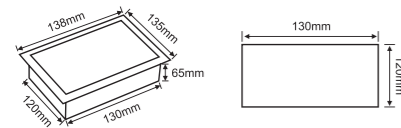

- Pop up Boxes is ideal for meeting rooms and conference rooms
- Hydraulic soft-closing mechanism.
- Round Button activated soft opening.

RM302 Hydraulic Pop up Outlet Box

Material	Zinc alloy
Finishes	Painting silver, powder coated black
Size	138*135*67mm
Open hole size	138*135*7 mm

Configuration (Customizable)



- 1 Power
- 1 RJ45 Data
- 1 RJ11

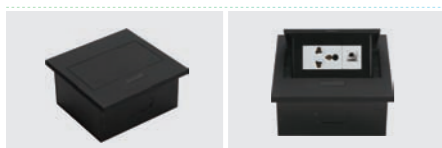
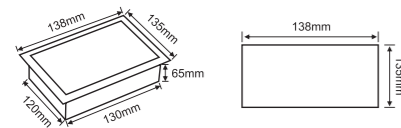

RM303 Hydraulic Pop up Outlet Box

Material	Zinc alloy
Finishes	Painting silver, powder coated black
Size	264*115*67mm
Open hole size	224*110*65 mm

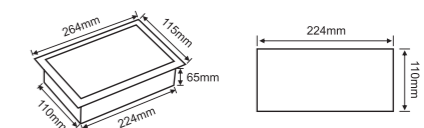

Configuration (Customizable)

[A] 2 Powers, 1 RJ45 Data, 1 RJ11, 1 VGA, 16. 35Microphone.

[B] 2 Powers, 1 RJ45 Data, 1 RJ11, 1 VGA, 1 HDMI, 1 USB





RM305 Hydraulic Pop up Outlet Box

Material	Zinc alloy
Finishes	Painting silver, powder coated black
Size	263*130*68mm
Open hole size	263*130*7mm

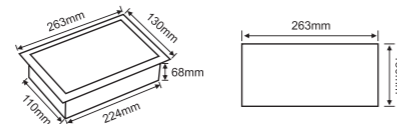

Product features

- Plug this pop box and play with hydraulic soft-opening.
- **Square Button** activated soft opening.
- Power and data connectivity inside your table top for optimal cable management and convenience.
- Similar to RM303, , **RM305 with square edge.**

Configuration (Customizable)

- [A] 3*Schuko powers / French powers
- [B] 2 Powers, 1 RJ45 Data, 1 RJ11, 1 VGA, 1 HDMI, 1 USB.



RM801 Desktop Pop-up Multimedia Outlet

Material	Aluminum
Finishes	Brushed silver,Brushed black
Size	158*132*152mm
Open hole size	148*121*150mm

Configuration (Customizable)

- 1 Powers, 1 RJ45 Data, 1 RJ11, 1 VGA, 1 HDMI, Video,RCA audio

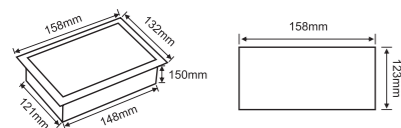

RM802 Built-in Socket Outlet

Material	Aluminum
Finishes	white, Silver, Black ,Brushed silver/Black(Color customizable)
Size	φ 90
Open hole size	φ 80

Configuration (Customizable)

- [A] 1*Power or 2*USA Socket 1*USB charge

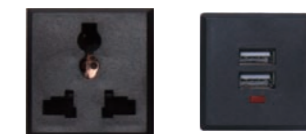



RM501

Motorized Revolving Flip-up Multimedia Outlet

Material	Aluminum+ABS
Finishes	Painting silver, powder coated black
Conventional color	White, Silver(Customizable)
Size	355*110*103mm(8 modules)
Open hole size	322*104mm

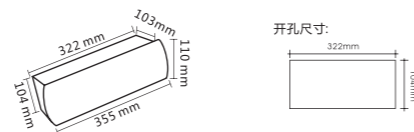

Configuration (Customizable)

- 8 modules: 2 Powers, 1 RJ45 Data, 1 RJ11, 1 VGA.
- 10 modules: 2 Powers, 2 RJ45 Data, 1 HDMI, 1 VGA, 1 USB, 1Microphone.



Product features

- The **automatic motorized** functions let you conveniently open and close the panel with ease when not in use. It integrates the electronics technology and automation into the modern furniture and humanize with the automation and safety.
- **Hides all the connectors** through one button when not in use, in order to avoid accident caused by drop and foreign bodies, and also get effect of beauty and decoration. It has the **photoelectric lock** out to prevent the vault from closing when anything is plugged into the unit; this feature also avoids the potential cord damage and hand injury.
- **Pre-wired** with 1.5m cable. Connect desktop equipment conveniently. Ideal for meeting rooms and conference rooms.
- Modules customizable for request adapt to different environment

RM502

Manual Revolving Flip-up Multimedia Outlet

Material	Aluminum+ABS
Finishes	Painting silver, powder coated black
Size	298*110*103mm
Open hole size	266*104mm

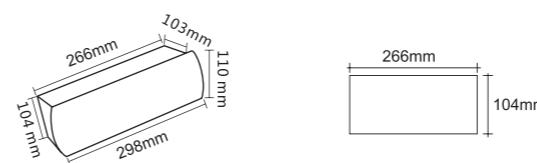

Configuration (Customizable)

- 7 modules: 2 Powers
- 1 RJ45 Data,
- 1 RJ11
- 1 VGA.



RM503

Motorized Revolving Flip-up Multimedia Outlet

Material	Aluminum+ABS
Finishes	Brushed silver,Brushed black
Size	340*110*102mm (8 modules)
Open hole size	330*102*99 mm

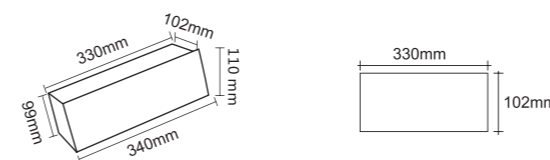

Configuration (Customizable)

- 8 modules: 2 Powers
- 1 RJ45 Data,
- 1 RJ11
- 1 VGA.





RM606 Movable Clamp-on Outlet Solution

Material	Aluminum+ABS
Finishes	Anodized silver
Size	285*60*50mm

Configuration (Customizable)

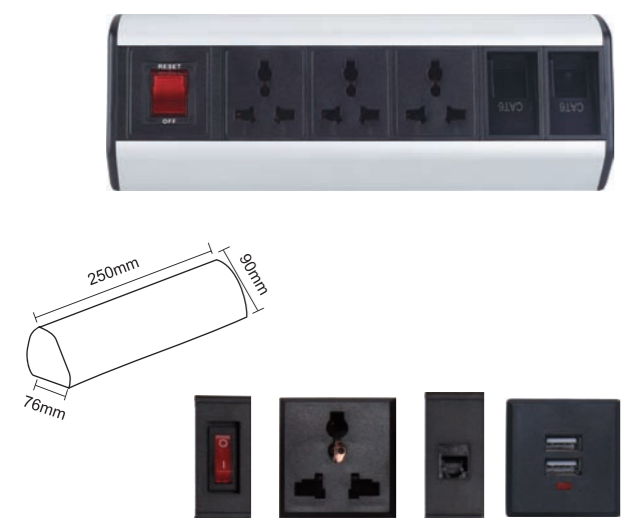
1 Switch
3 Powers
1 Dual USB charger 2.1A
1 Data RJ45

RM607 Clamp-on Outlet Solution

Material	Aluminum+ABS
Finishes	Anodized silver
Size	250*90*76mm

Configuration (Customizable)

1 Switch
3 Powers
1 Dual USB charger 2.1A
1 Data RJ45

RM608 Movable Clamp-on Outlet Solution

Material	Aluminum+ABS
Finishes	Anodized silver
Conventional color	White, Silver(Customizable)
Size	240*60*76mm

Configuration (Customizable)

1 Switch
3 Powers
1 Dual USB charger 2.1A

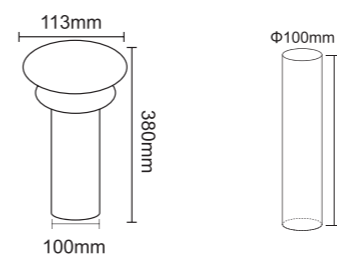

- Pre-wired with 1.5m cable. Connect desktop equipment conveniently
- Easy to fit or retro-fit, and fits flush to work surfaces.
- Modules customizable for request to fit different environment

RM601 Hydraulic Pop-up socket

Material	Aluminum+ABS
Finishes	Anodized silver
Size	113*380mm
Open hole size	Φ100mm

Configuration (Customizable)

1 Switch
3 Powers
1 Dual USB charger 2.1A

Product features

- RM601 has a simple installation process and is ideal for saving space in a kitchen or office environment.
- Hydraulic lifting mechanism: Plug this pop box and play with soft opening.
- Capable of charging the latest tablets and phones
- Pre-wired with 1.5m cable. Connect desktop equipment conveniently
- Easy to fit or retro-fit, and fits flush to work surfaces.
- Modules customizable for request to fit different environment

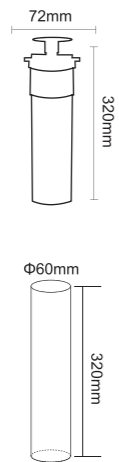
RM602 Retractable Pull Up Outlet

Material	Aluminum+ABS
Finishes	Anodized silver
Size	72*320mm
Open hole size	Φ60mm

Configuration (Customizable)

1 Switch
3 Powers
1 Dual USB charger 2.1A

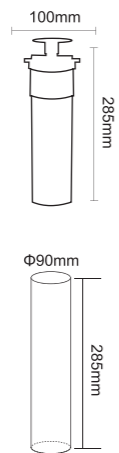
RM603 Retractable Pull Up Outlet

Material	Aluminum+ABS
Finishes	Anodized silver
Size	100*285mm (Length customizable)
Open hole size	Φ90mm

Configuration (Customizable)

2 Powers 2 Data RJ45
1 HDMI
1 VGA

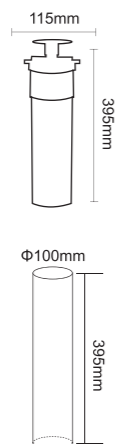
RM604 Retractable Pull Up Outlet

Material	Aluminum+ABS
Finishes	Anodized silver
Size	115*390mm
Open hole size	Φ100mm

Configuration (Customizable)

1 Switch
3 Powers
1 Dual USB charger 2.1A

RM605 Electrical Motorised Pop Up Outlet

Material	Aluminum+ABS
Finishes	Anodized silver
Size	120*370mm
Open hole size	Φ102mm

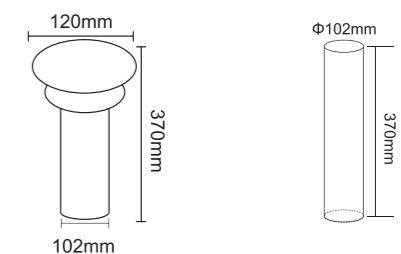

Product features

- Space saving pop up socket.
- Capable of charging the latest tablets and phones.
- Features a built in **Bluetooth wireless audio speaker**.
- Includes an anti-trap safety feature : if someone leaves an object on the travel track while it is lowering, it will **automatically** stop and raise again after three seconds.
- The socket top features flashing **LED lights** when the unit is in motion
- Press 3 seconds to activated **children safety lock** that keep children protection from power.

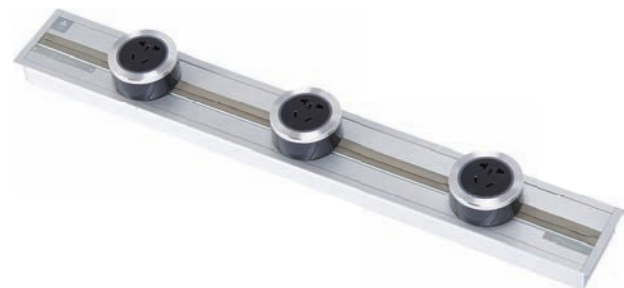

DG01 Power Track

Product features	Built-in power outlet track, length customizable
Material	Aluminum
Rated Voltage	240V a.c.
Rated Current	32 Amp maximum
Size	610*80*35mm
Open hole size	600*70*33mm



Product features

- Elegant design – **Sleek and premium finishing.**
- **Flexible:** Add, remove and reposition power outlets adaptor anywhere along the power track.
- Safety: **GSS System** which grounds all conductive objects.



DG02 Power and Data Outlet Track

Product features	Built-in power outlet track, length customizable
Material	Aluminum
Rated Voltage	240V a.c.
Rated Current	32 Amp maximum
Size	610*80*57mm
Open hole size	600*70*55mm



DG03 Power and Data Outlet Track

Product features	Hanging type power outlet track, length customizable
Material	Aluminum
Rated Voltage	240V a.c.
Rated Current	32 Amp maximum
Size	600*100*30mm
Open hole size	600*70*33mm



DG04 Power & Cable Management Track

Product features	Hanging type power outlet track, length customizable
Material	Aluminum
Rated Voltage	240V a.c.
Rated Current	32 Amp maximum
Size	800*70*30mm



DG05 Power and Data Outlet Track

Material	Aluminum
Rated Voltage	240V a.c
Rated Current	32 Amp maximum
Size	500*68*15mm
Cut Out Dimension	491*60*19mm

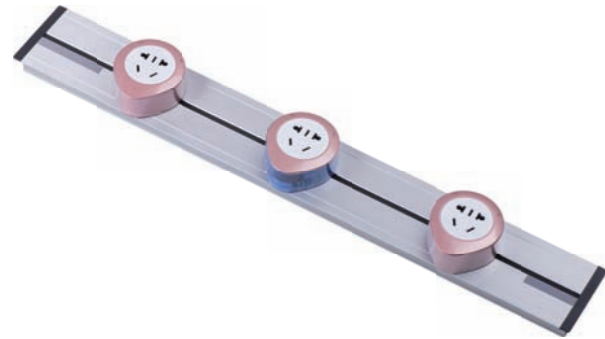

Product features

- Built-in Power Outlet Track, Length Customizable
- Flush Mounting

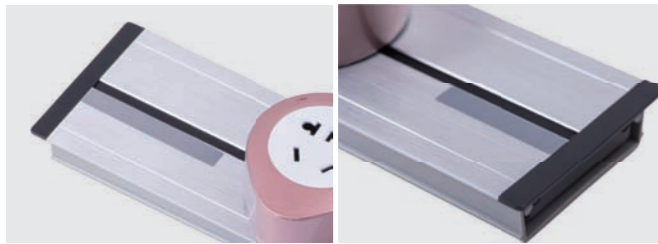

DG06 Power and Data Outlet Track

Material	Aluminum
Rated Voltage	240V a.c
Rated Current	32 Amp maximum
Size	500*68*15mm

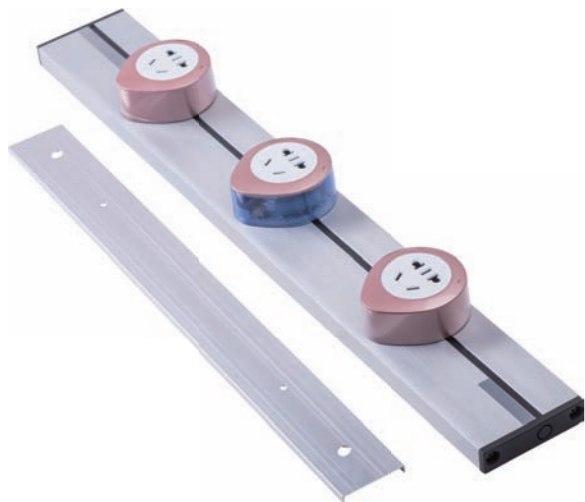

Product features

- Built-in Power Outlet Track, Length Customizable
- Surface Mounting



ZD001 Built-in 3 port Charging USB

Adaptor	5V/3.1A or 5V/2.1A
USB Cable	1.5m
Material	Fire retardant PC+ ABS
Finishes	Silver, White, Rose Gold
Size	Φ67*80mm
Open hole size	Φ50mm

Product features

- Multi-devices **fast charging**: 3 ports total 3.1A .Max 2.1A one port.
- **Space saving** USB charger fixed on tabletop or **sofa**.
- Has a simple installation process and is ideal for saving space in a sofa or tabletop.



ZD002 Built-in 3port Charging USB

Input	AC100-240V, 50/60Hz, 0.15A Max
Output	DC 5V/3100mA
Power Cable	1.5m
Material	Fire retardant PC+ ABS
Finishes	White, Black
Size	Φ67*80mm
Open hole size	Φ50mm

Product features

- Multi-devices **fast charging**: 3 ports total max 3.1A .Max 2.1A one port.
- **Space saving** USB charger fixed on tabletop or **sofa**.
- **Recessed neatly** in the surface of the furniture when not in use.
- A simple installation process by 4 screws fitting in 50mm hole.
- Has a **simple installation** process and is ideal for saving space in a sofa or tabletop.



ZD003 Built-in 3 port Charging USB

Adaptor	5V/3.1A or 5V/2.1A
USB Cable	1.5m
Material	Fire retardant PC+ ABS
Finishes	Silver,White,Rose Gold
Size	Φ67*80mm
Open hole size	Φ50mm

Product features

- Multi-devices **fast charging**: 3 ports total 3.1A .Max 2.1A one port.
- **Space saving** USB charger fixed on tabletop or **sofa**.
- Has a simple installation process and is ideal for saving space in a sofa or tabletop.



ZD004 Built-in 3port Data USB

Material	Fire retardant PC+ ABS
Size	67*80mm
Open hole size	Φ50mm
Finishes	Silver, White, Black

Product features

- Multi-Devices :3 port
- Space saving USB data Fixed On table or sofa
- Has a simple installation process and is ideal for saving space in sofa or table

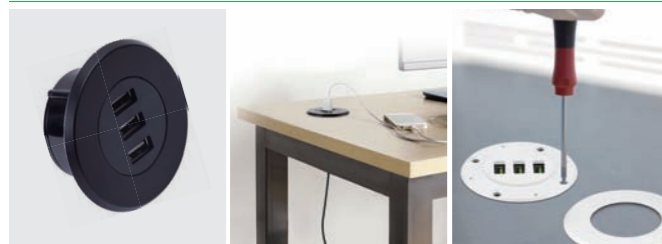

YS01 LCD Lift mechanism

Feature	Save power. Power connection when LCD lift up and disconnection when disconnection. Protection of electrical components. Adjustable of angle for screen.
Suitable for	17~21 inch screen
Control model	Manual control, Remote control
Voltage	AC220 Å ± 10% 50Hz or 110V 60Hz
Material	Aluminum alloy+Steel
Finishes	Brushed silver, Brushed black
size	620*140*705mm(for 21inch)
Open hole size	605*120*702mm



Product features

- Save power.Power connection when LCD lift up and disconnection.Waterproof protection for electrical components. Automatically tilting angle for screen



MA001 Monitor Arm

Material	Aluminum
Finishes	Anodized silver
Diameter	Φ58
Size	381mm or 750mm

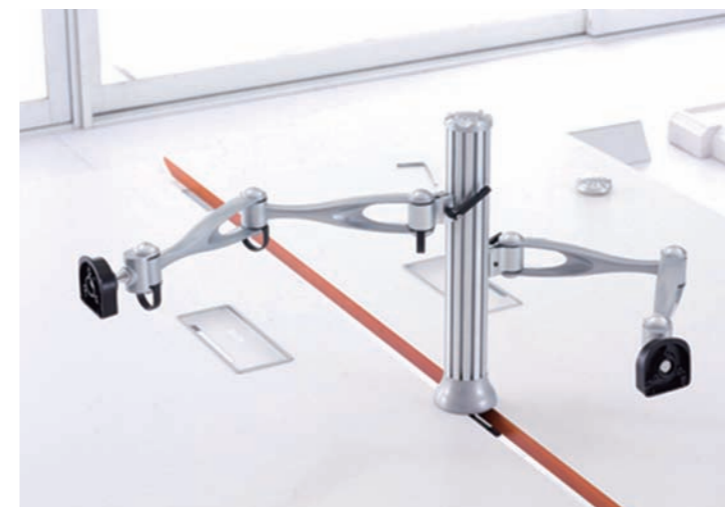



WX01 Built-in Wireless Charger

Color	Black, White
Input	DC 5V/2A
Output	Wireless DC 5V/1A
Diameter	Φ 76mm
Cut out size	Φ 60mm
Fitting USB cord and Adaptor	



WX02 Built-in Wireless Charger

Color	Black, White
Input	DC 5V/2.0A,9V/1.8A
Output	Wireless 5W,7.5W,15W
Diameter	Φ 76mm
Cut out size	Φ 60mm
Fitting USB cord and Adaptor	

Color Selections of Aluminum surface treatment

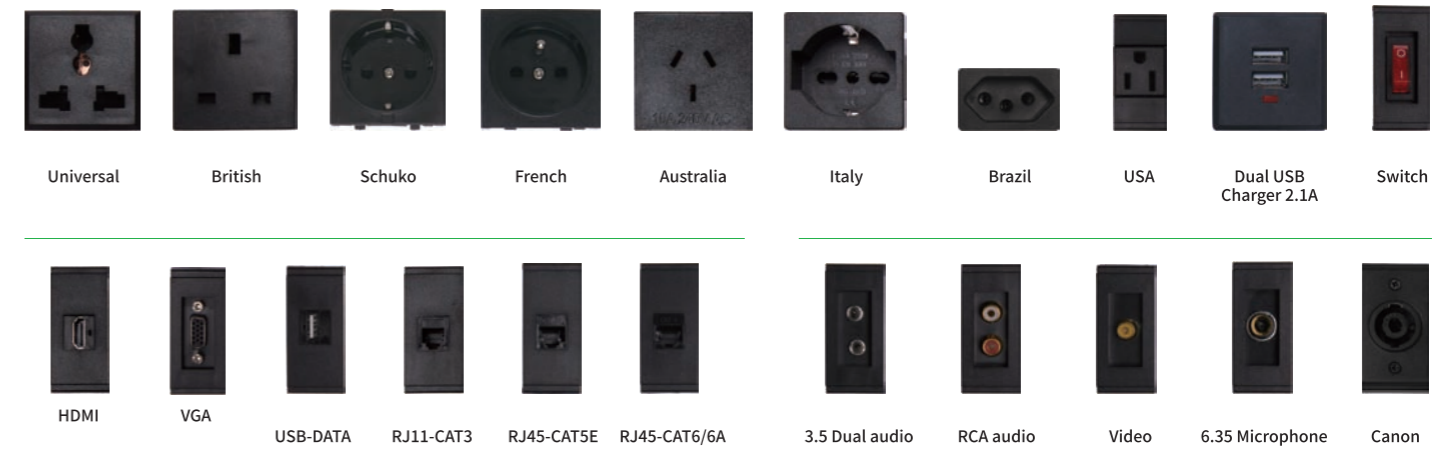
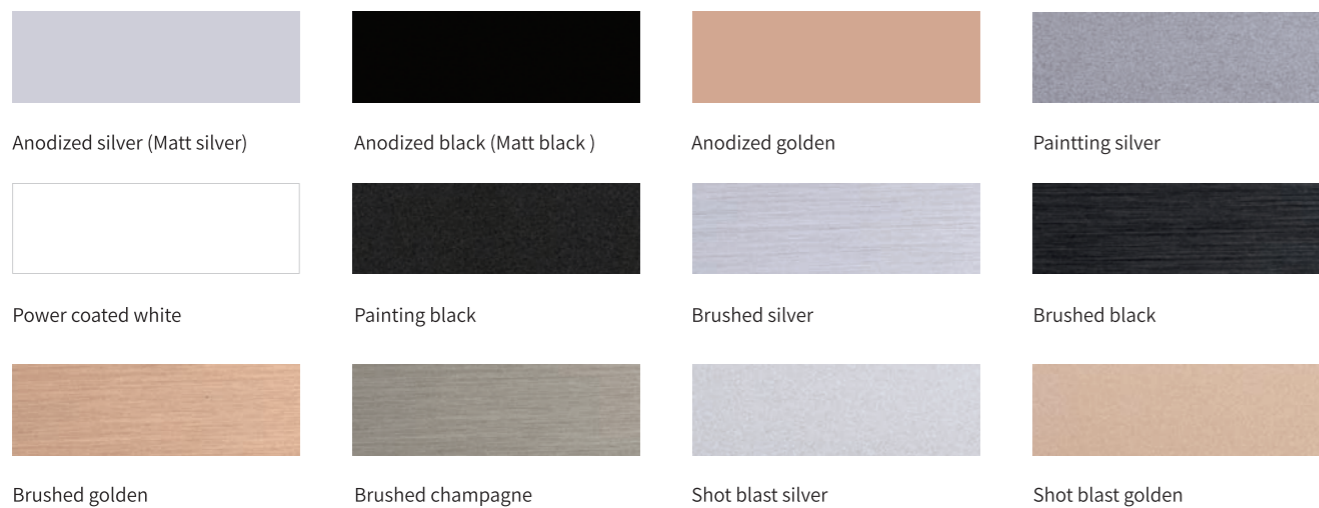



TJ001 Table Frame / Table Leg

Material	Aluminum
Size (Customizable)	1200*600*725/ 1400*600*725 (L*W*H)



TJ003 Table Frame / Table Leg

Material	Aluminum
Size (Customizable)	1200*600*725/ 1400*600*725 (L*W*H)



TJ002 Table Frame / Table Leg

Material	Aluminum
Size (Customizable)	1200*600*725/ 1400*600*725 (L*W*H)



TJ004 Table Frame / Table Leg

Material	Aluminum
Size (Customizable)	1200*600*725/ 1400*600*725 (L*W*H)





TJ005 Table Frame / Table Leg

Material	Aluminum
Size (Customizable)	1200*600*725/ 1400*600*725 (L*W*H)



PX001 Folding desk

Feet	3.0 MM, hot rolled steel
Frame	3.0 MM cold rolled steel, electrostatic painting
Partition	1.0 MM, cold rolled steel, electrostatic painting
Castor	2pcs 2 inch nylon black casters with lock and 2 without lock
Features	Stable, strong
Application	Meeting room, training room, hotel multi-function hall, classroom, top restaurants



TJ007 Table Frame / Table Leg

Material	Aluminum
Size (Customizable)	1200*600*725/ 1400*600*725 (L*W*H)



PX002 Folding desk

Feet	3.0 MM, hot rolled steel
Frame	3.0 MM, cold rolled steel, electrostatic painting
Partition	1.0 MM, cold rolled steel, electrostatic painting
Castor	2pcs 2 inch nylon black casters with lock and 2 without lock
Features	Stable, strong, with partition
Application	Meeting room, training room, hotel multi-function hall, classroom, top restaurants





PX003 Folding desk

Feet	3.0 MM press-casting aluminum,chroming
Frame	1.8MM aluminum
Partition	1.0 MM, electrostatic painting, black
Castor	2 inch nylon casters, with lock and without lock
Features	Beautiful appearance generous,with control device of opening and closing
Application	Meeting room, training room, hotel multi-function hall, classroom, top restaurants



PX004 Folding desk

Feet	2.0 MM, cold rolled steel, square tube
Frame	2.0 MM cold rolled steel
Partition	1.0 MM, electrostatic painting, black
Castor	2 inch nylon casters, with lock
Features	Stable, strong
Application	Meeting room, training room, hotel multi-function hall, classroom, top restaurants



TT01 Manual Lifting Column

Type	Manual, with folding rotating handle
Adjustable height	310-730mm
Top plate	300*300*310mm

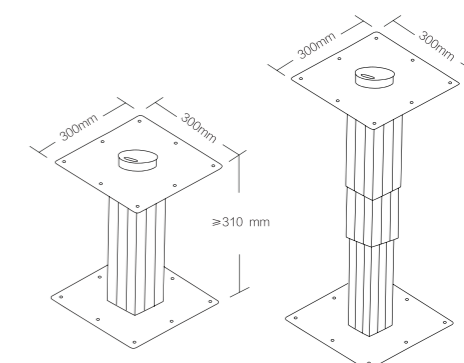



TT02 Hydraulic Lifting Column

Type	hydraulic actuation, manual adjust, with cylinder inside
Adjustable height	410-710mm
Top plate	295*295*410mm

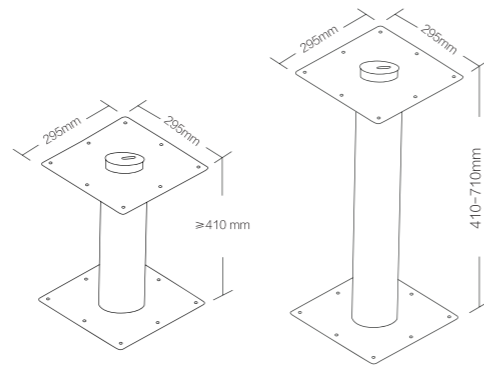

TT03 Electrical Lifting Column

Type	electrical lifting, with wireless controller
Adjustable height	310-725mm
Top plate	300*300*310mm

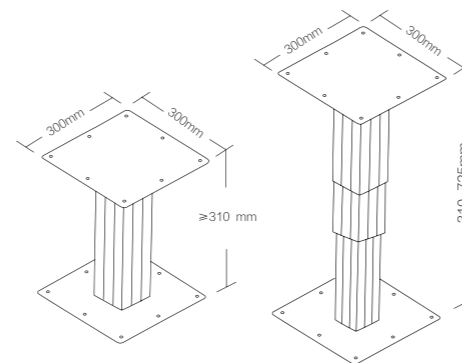

Accessories series





RM701 Partition Clamp Shape "T"

Material	Aluminum
Finishes	Powder coated white (Customizable)
Clamp	4-20mm board/glass

Product features

- T foot partition clip to connect two desktop partition;
- With a soft rubber plastic pad to prevent sliding plate/glass and damage, safety is strong;
- Aluminum alloy material, installation solid;
- Fine surface treatment should not be rust and corrosion resistance is strong

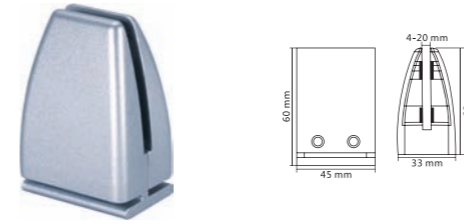
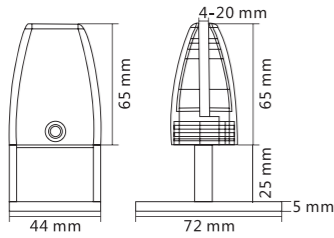

RM705 Partition Clamp

Material	Aluminum
Finishes	Shining silver
Clamp	4-20mm board/glass

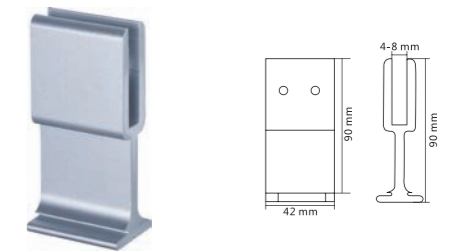

RM707 Partition Clamp

Material	Aluminum
Finishes	Anodized Silver
Clamp	4-8mm board/glass



RM702 Partition Clamp Shape "L"

Material	Aluminum
Finishes	Powder coated white (Customizable)
Clamp	4-20mm board/glass

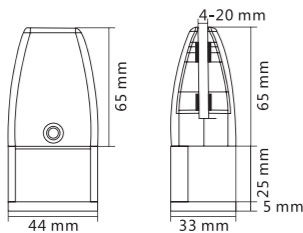

DM001 Partition Clamp

Material	Aluminum
Finishes	Powder coated white, Painting silver (Customizable)
Clamp	68*50*142 (L*W*H)

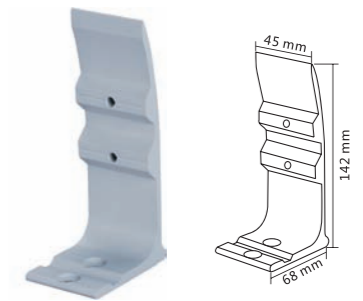

DM002 Partition Clamp

Material	Aluminum
Finishes	Powder coated white, Painting silver (Customizable)
Clamp	68*45*142 (L*W*H)



RM703 Partition Clamp

Material	Aluminum
Finishes	Powder coated white (Customizable)
Clamp	4-20mm board/glass

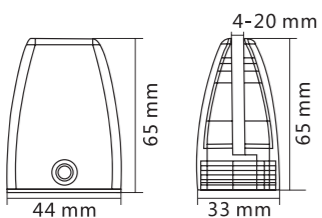

DM003 Partition Clamp

Material	Aluminum
Finishes	Powder coated white, Painting silver (Customizable)
Clamp	100*20*142 (L*W*H)

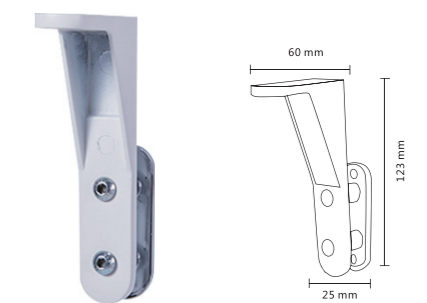

DM004 Partition Clamp

Material	Aluminum
Finishes	Powder coated white, Painting silver (Customizable)
Clamp	60*25*123 (L*W*H)



TQ001(50mm)

Ventilator



Material	Aluminum
Finishes	Oxidizing,Brushed (Customizable)
Product Size	Width 50mm (Length customizable)

TQ002(60mm)

Ventilator



Material	Aluminum
Finishes	Oxidizing,Brushed (Customizable)
Product Size	Width 60mm (Length customizable)

TQ003(80mm)

Ventilator



Material	Aluminum
Finishes	Oxidizing,Brushed (Customizable)
Product Size	Width 80mm (Length customizable)

TQ004(80mm)

Ventilator with Circular Hole



Material	Aluminum
Finishes	Oxidizing,Brushed (Customizable)
Product Size	Width 80mm (Length customizable)

TQ005

Plastic Ventilator

Color: Black, White (Color customizable)
Material: ABS



Size: 120*380mm Open hole size: 102*360mm

JP002

Keyboard Tray

Color: White, Black
Material: ABS



Size: 535*320*35 (L*W*H)

JP004

Keyboard Tray

Color: Black
Material: Steel

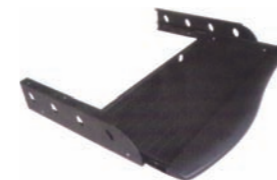

Size: 550*270*35 (L*W*H)

JP001

Keyboard Tray

Color: White, Black
Material: ABS



Size: 535*320*35 (L*W*H)

JP003

Keyboard Tray

Color: White, Black
Material: ABS

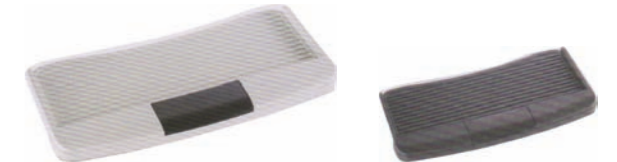

Size: 550*270*35 (L*W*H)

JP005

Keyboard Tray

Color: Gray, Black
Material: Steel



Size: 510*150*12 (L*W*H)

YB01

Metal Grommet



Material	Zinc alloy
Finishes	Chroming, Painting silver, Brushed bronze
Product Size	Φ50mm, Φ60mm, Φ80mm



YH01

Metal Grommet

Material	Zinc alloy
Finishes	Chroming,Painting
Product Size	Φ50mm, Φ60mm, Φ80mm



XG001 Cable Management



Elliptic
ABS.
Silver, Black, White
750mm (Length coustomizable)



ZJ001 CPU Holder



Width adjustable	170-250mm
Material	Steel
Finishes	Gray white
Product size	310*(170-250)*140mm

ZJ002 CPU Holder



Width adjustable	150-260mm
Material	ABS
Finishes	Gray white
Product size	320* (150-250) *150mm

ZJ003 CPU Holder

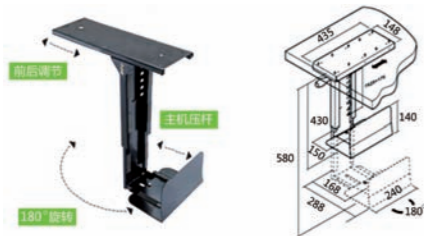

Material	Rolled Steel
Finishes	Black, Silver
Extend	Moved ± 150mm forward or backward,swivel 180°
Height adjustable	± 150mm

ZJ004 CPU Holder

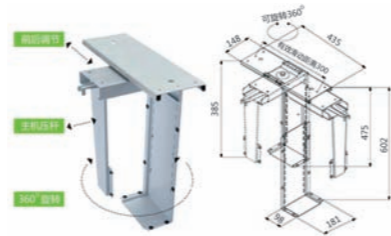

Material	Rolled Steel
Finishes	White
Extend	Moved ± 150mm forward or backward,swivel 360°
Height adjustable	± 150mm



XG002 Cable Management



Circal
ABS.
Silver, Black, White
750mm (Length coustomizable)

XG003 Cable Management



Elliptic
ABS.
Gray
750mm (Length coustomizable)

XG004 Cable Management



Squre
ABS.
Silver, Black, White
750mm (Length coustomizable)

PF001 Acrylic Partition



Material: Acrylic
 Finishes: Transparent, Frosted, Green, Blue, Black, White, Orange, Tea brown
 (Color customizable)
 Size: 900*300*5mm (Customizable)



GC001 Steel Drawer



Material: Steel
 Finishes: Black
 Size: 410*360*80mm

GL001 Aluminum Partition



Material	Aluminum
Finishes	Powder Coated White
Size	1200*320*40mm (Length customizable)

LG01 Desktop Trunking



Material	Aluminum
Finishes	Anodized Silver
Size	Length customizable

LG02 Desktop Trunking



Material	Aluminum
Finishes	Anodized Silver
Size	Length customizable

ZJ201 CPU holder Wheel



Material	ABS
Finishes	Black, White, Yellow, Purple, Red, Green
Size	Suitable for 18/25mm board

JK001 Desk Connector

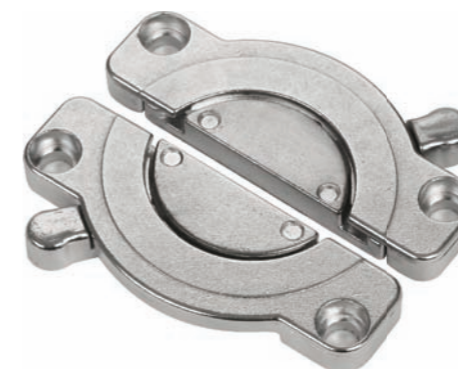

Material	Zinc
Finishes	Chroming